



**SCAN HERE TO
REGISTER YOUR
REID eSCOOTER**

@REIDBIKES

REID **ROVER** **OWNER'S PACK**



**SCAN HERE TO
REGISTER YOUR
REID eSCOOTER**

BUILD ME

Pages 1-10

APP INTEGRATION

Pages 31-34

RIDE ME

Pages 11-22

JOIN THE COMMUNITY

Pages 35-42

MAINTAIN ME

Pages 23-30

ENVIRONMENTAL PLEDGE

Pages 43-48

BUILD ME

1

2

1. This appliance can be used by riders 14 years and above only. Children shall not play with the appliance. Cleaning and user maintenance shall not be made by children without supervision.
2. This manual can also be downloaded from the website: www.reidbikes.com
3. **WARNING:** For the purposes of recharging the battery, only use the detachable supply unit provided with this appliance.
4. When product is discarded:
 - (1) the battery must be removed from the appliance before it is scrapped;
 - (2) the appliance must be disconnected from the supply mains when removing the battery;
 - (3) the battery is to be disposed safely
5. This appliance contains batteries that are non-replaceable.

WARNING

This eScooter is designed for commuting on smooth flat surfaces with one rider only. It is not for use on:

- Rough and uneven surfaces
- Jumping on or off curbs or any other object
- Skate Parks

Using this eScooter in any way other than intended will void your warranty.

Check wheel nuts and bolts regularly and do not ride if they are loose.

About The Manual

This manual applies to your Reid Rover electric scooter. Please read the manual carefully to ensure that:

1. You quickly grasp the basic operating procedures and riding methods of your Reid Rover electric scooter.
2. You familiarise yourself with safe driving rules for a safe and enjoyable scooter experience.
3. You understand the composition and safety of your Reid Rover electric scooter.

If you have any questions or need more information, please visit www.reidbikes.com

Please pay attention to the following signs and relating content:



Dangers!

Could cause serious property damage or personal injury



Warnings!

Improper operations can lead to the malfunction of the product



Information tips

What Comes In The Box

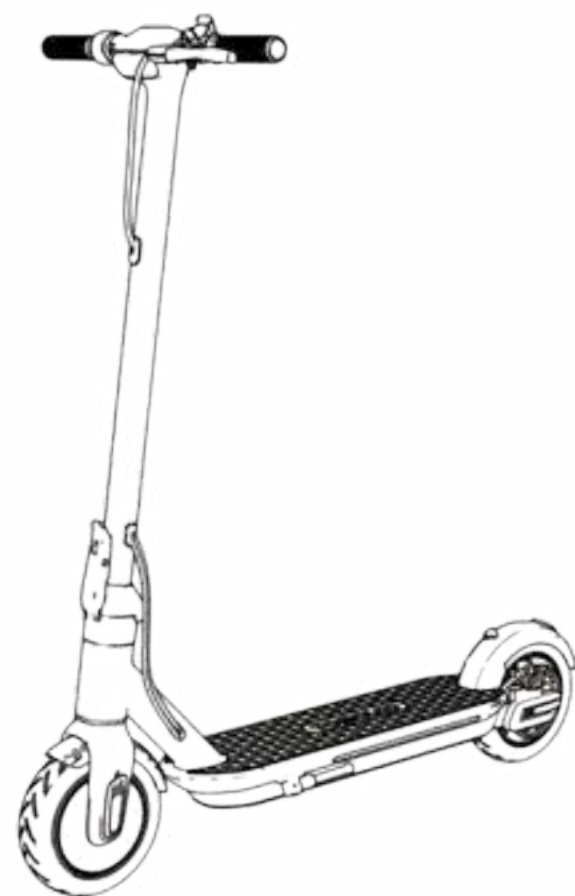

Components

User manual x1

Screw M5 x 5



Hex wrench M5 x1, M3 x 1



M5 M3

Charger adapter x1

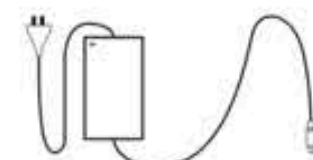

*Please check carefully that the parts in the package are intact.

Components

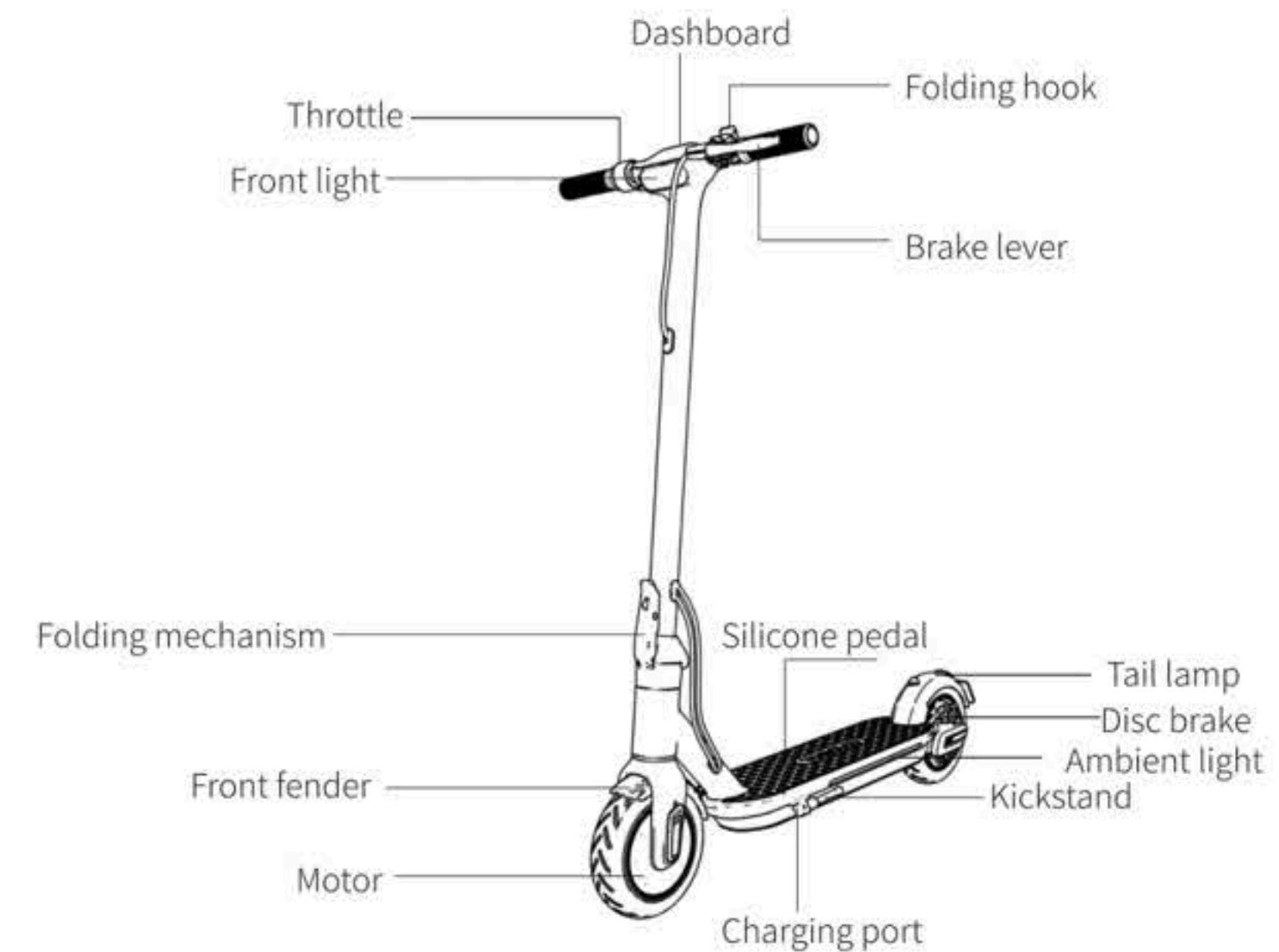

Control Panel

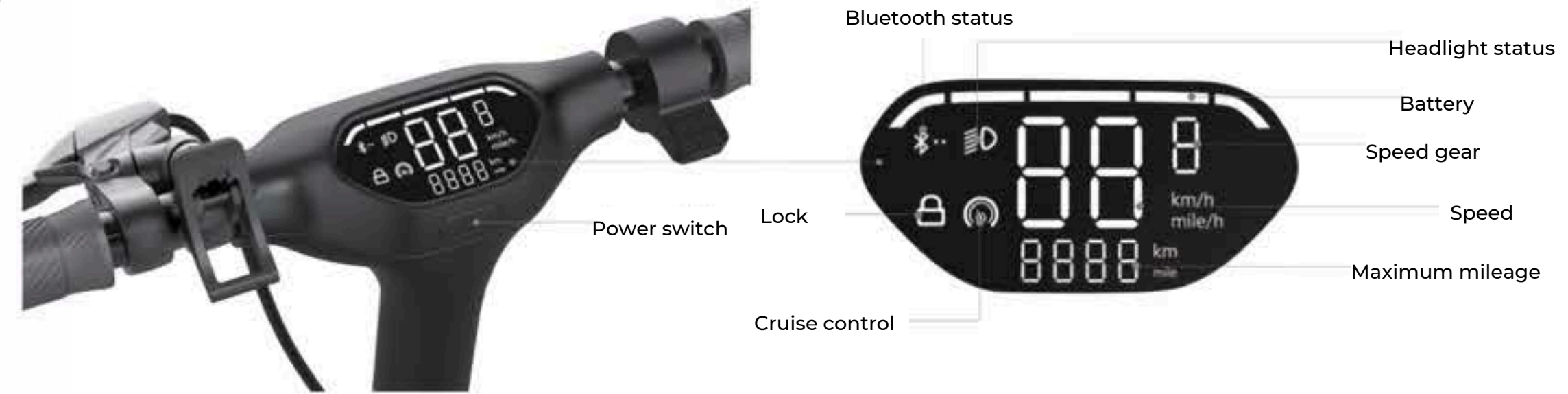

Control Instructions:

- Use the control panel to control the scooter, the specific features are as follows:
1. Long press the power switch button to turn on the eScooter, also turning on the front light, ambient lighting, tail light and rear brake light. The control panel shows the power and speed.
 2. After turn on, the control panel display shows "1", indicating that the speed is 1st gear. Press the button to display 2nd gear; the highest is 3rd gear.
 3. Press the button twice to turn on the front light. Press the button twice again to turn it off.
 4. Press the button three times to display the total mileage. Pressing the button three times again will display the speed.
 5. When using the brake, the rear brake light will get brighter.
 6. The battery bar at the top equates to the following: Five Bars = 100%, Four Bars = 80%, Three Bars = 60%, Two Bars = 40% and One Bar = 20 %.

Installation Guide

Connect the wire for the head unit when attaching the head unit.



Install the brakes to the correct position with the Hex wrench (M5 in the tool bag).

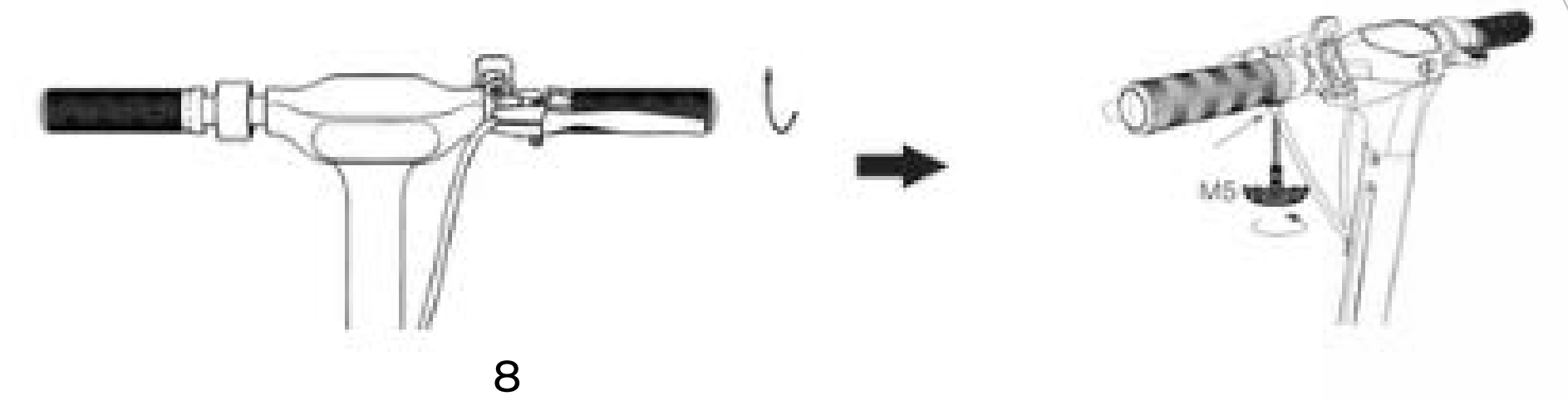

2. Hold the scooter upright, to ensure that the lock will not be affected, please keep the folding-spanner.

(the blue part of the image) at the bottom. Pull the folding-spanner to the top, then the scooter is con

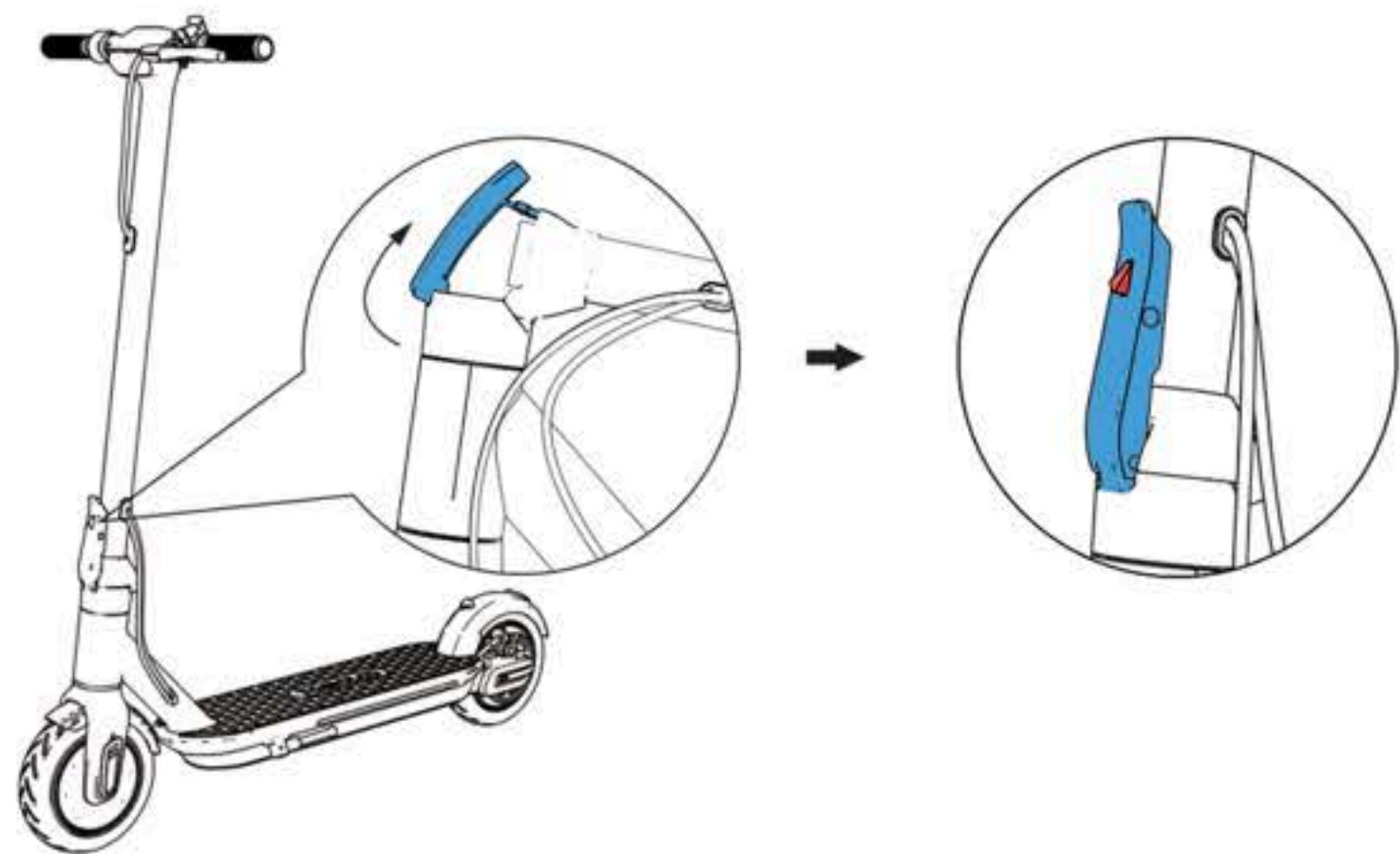

3. Fasten the scooter standpipe and fold out the kickstand.



5. Use the hex wrench in the tool bag to lock the screws on both sides.



4. Install the handlebar to the standpipe.

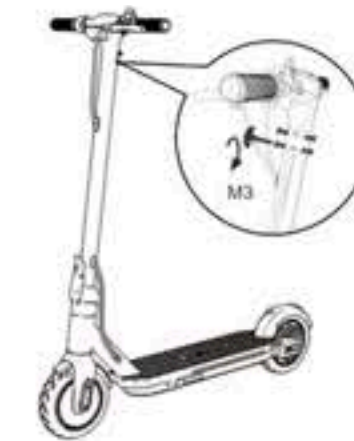

6. After the installation is complete, switch the scooter on and off to check that the scooter is working properly.



RIDE ME

Charging Instructions

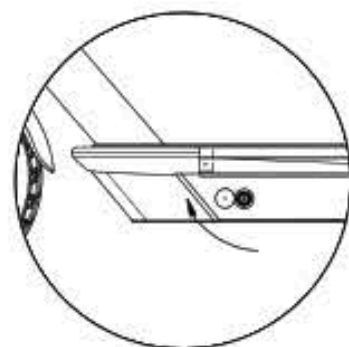

①

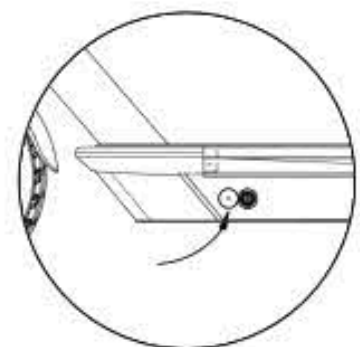

②

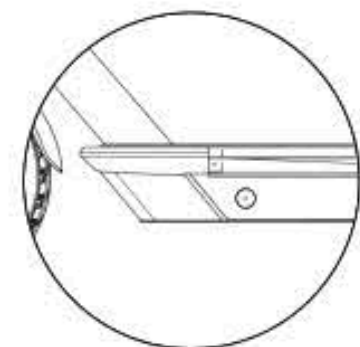

③

- Open the rubber cap.
- Insert the charging plug.
- After charging is completed, close the rubber cap to prevent water penetration.
- Charging takes 5-6 hours.

Safety Instructions

Your Reid eScooter is a sporting entertainment tool that is not a vehicle. If you drive it into a public area there are multiple safety risks not just to yourself but also to others. Strictly follow the instructions in this manual, to protect yours and others safety and to ensure compliance with national and provincial regulations and traffic regulations. It is important to understand that if you decide to take your Reid eScooter on a public road or other public place, you may be exposed to the risk of unauthorised driving / improper operation of your eScooter, even if you are in full compliance with our safe driving guide. You must strictly follow the safety requirements of this manual where there are no national standards and regulations for electric scooters. Reid shall not be liable for any liability, personal injury, accident, legal dispute and all other unfavourable events resulting from the use of violating the instructions indicated in this manual.

The faster the eScooter is driving, the longer the brakes need and on some smooth surfaces, using the left-hand brake can cause the wheels to slip and lose balance or even fall. Therefore it is important to be vigilant and maintain the proper speed during driving, whilst maintaining a reasonable safety distance to others. Please be vigilant and drive at low speeds before entering unfamiliar terrain.

Do not lend your Reid eScooter to a person who has never ridden it before to avoid injury. If you do lend your eScooter to someone, be sure to be responsible for the safety of them, you should teach them how to ride and tell them of how to ride safely, wearing the right safety gear.

Please check your Reid eScooter every time before driving. If you find that parts are loose, the battery life is minimum or there is abnormal sound or malfunction, then please stop using it immediately and do not force it to drive.

How To Ride

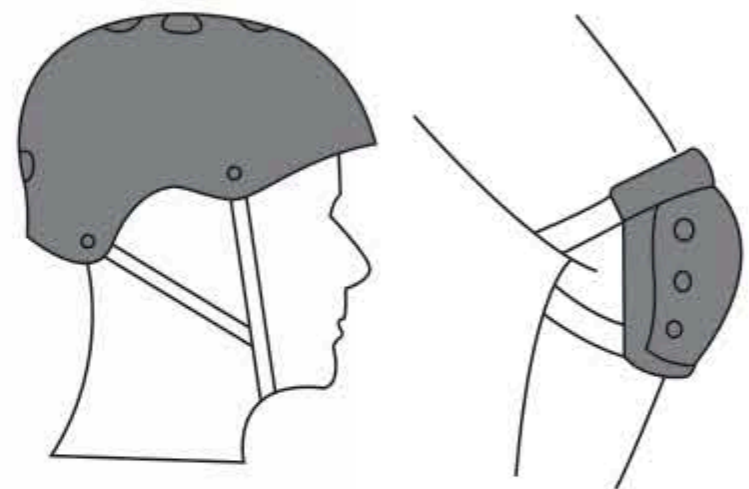

*There are risks of falling and injury when riding, so please wear a helmet and protective gear as shown in the picture.



1. Turn on the power and check the power indicator.



2. One foot stands on the deck, the other foot kicks backward.

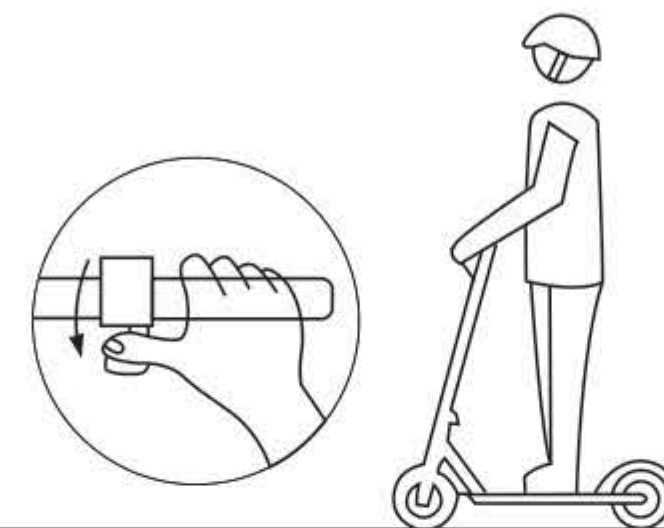

3. Once you have the electric scooter moving above 5km, put both feet on the deck and push the throttle to start the electric.

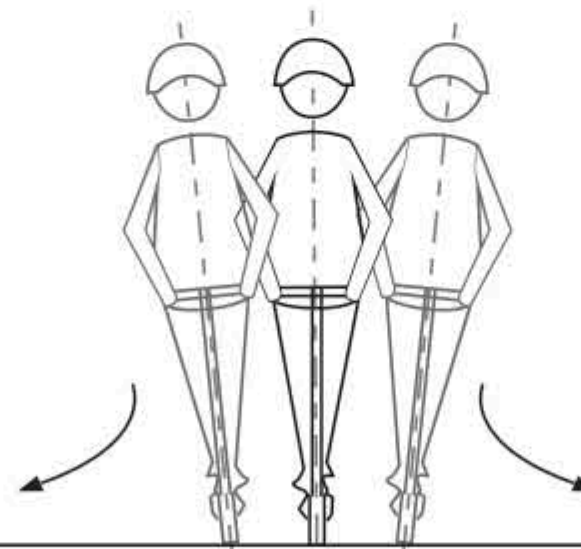

5. When turning, you need to lean your body slightly towards the direction you are turning and turn the handle slowly.



4. Releasing the throttle will slow you down gradually, with an automatic energy recover system coming in. For hard braking pull the lever on the left side.



6. Keep to one speed for approximately 8 seconds to start the cruise control. When you release the throttle, this then means the speed will remain unchanged. To cancel the cruise control, push the throttle or operate the brakes.

Riding Safely



⚠ Please avoid riding in the rain.

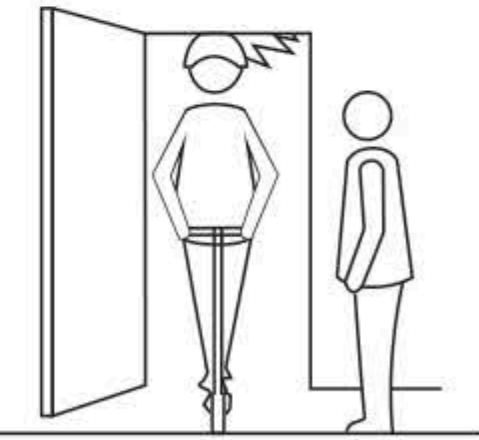

⚠ Do not ride through doorways.



⚠ Do not ride quickly over uneven surfaces. Keep a speed between 5km/h and 10km/h and bend your knees slightly to ensure maximum safety.



⚠ Do not accelerate downhill.

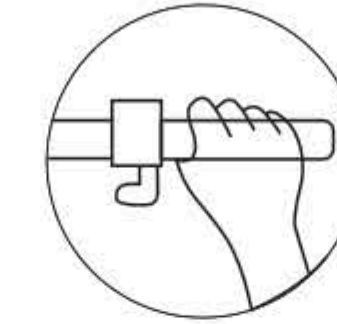

⚠ Do not press the throttle whilst walking with the eScooter.



⚠ Do not hang any heavy items on the handlebar.



⚠ Avoid obstacles when driving.



⚠ Keep both feet on the deck whilst driving.

Warning Reminder

Do not try to do any dangerous movements.

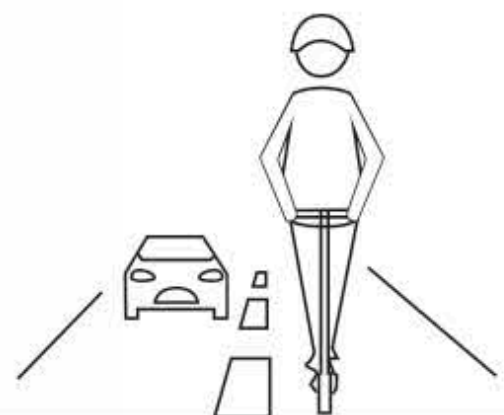

⊗ Forbidden to drive on the road or in crowded residential areas.

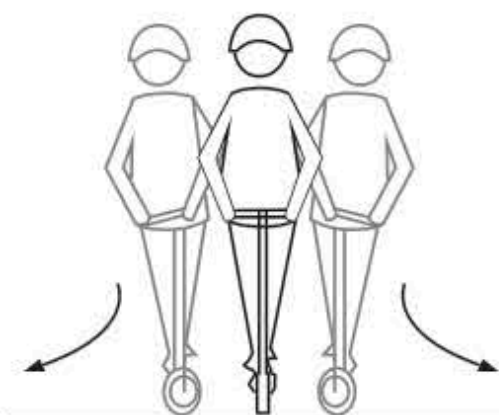

⊗ Forbidden to rotate the handle strongly while driving with high speed.



⊗ Forbidden to drive through water deeper than 2cm.

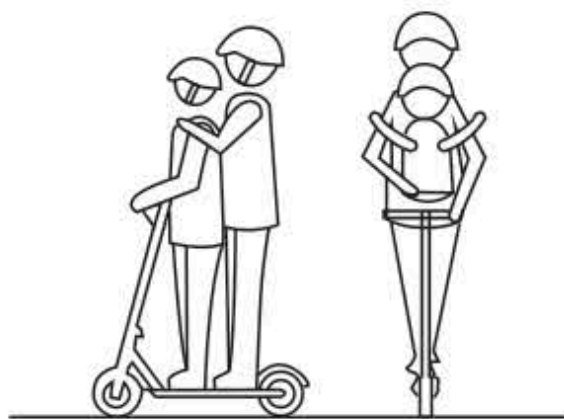

⊗ Forbidden to drive the eScooter with more than one person and/or holding a child.



⊗ Forbidden to step or tread on the back mudguard.

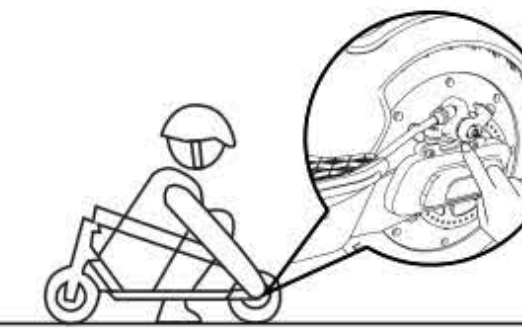

⊗ Forbidden to press the disc brake.

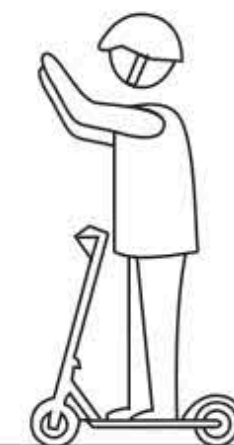

⊗ Forbidden to drive without your hands holding the handlebar.

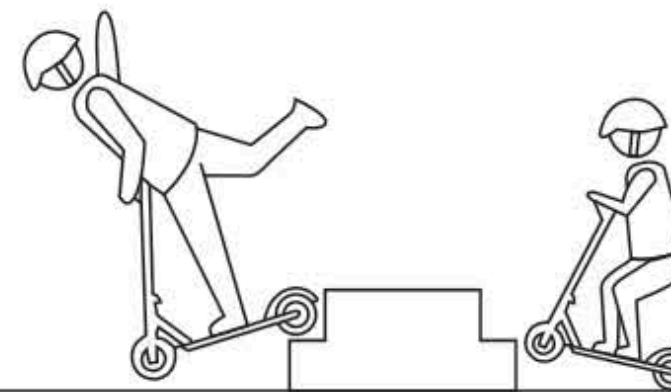

⊗ Forbidden to go up or down stairs or to jump over barriers when driving.

Folding and Transportation

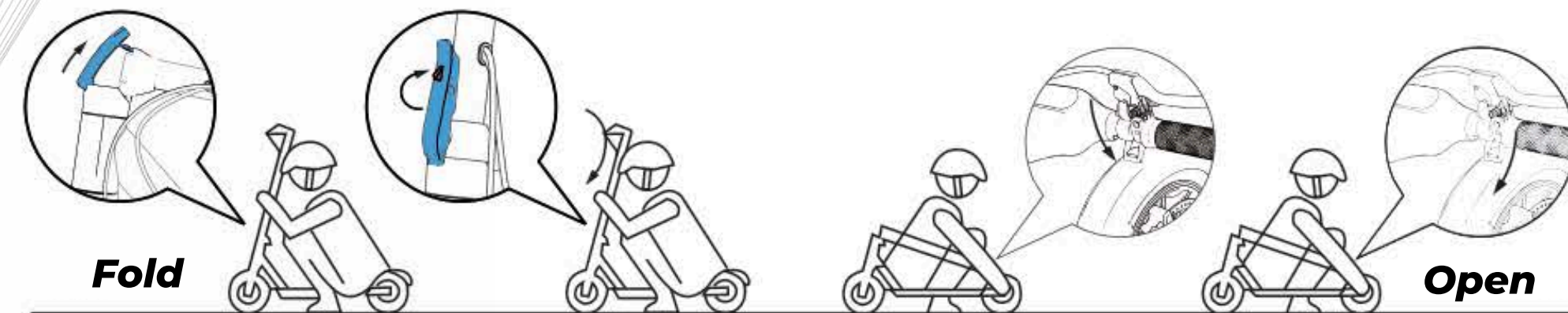

Put the safety-lock (the red part of the image) up whilst holding the steer tube. Then, open up the folding spanner (the blue part of the image) and aim it at the bell and fender hook. Next, buckle the belt with the back-fender.

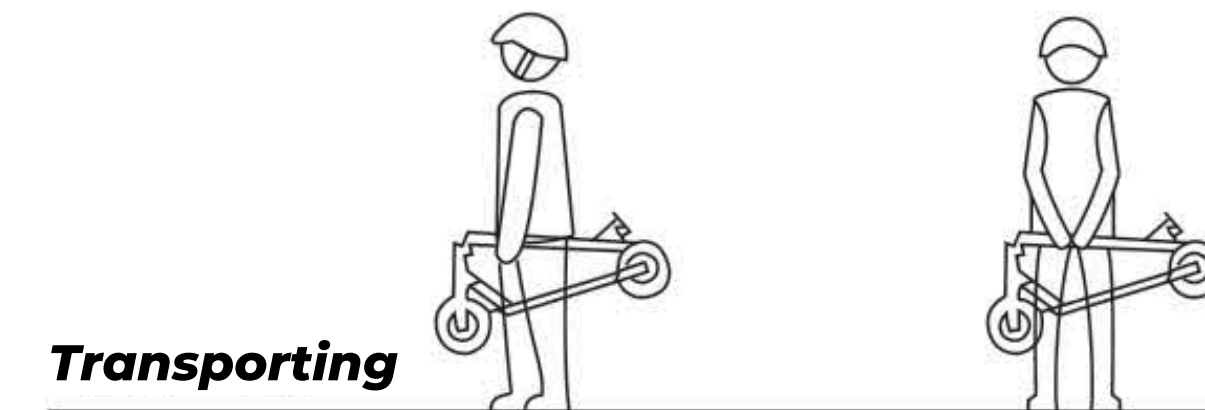

Transporting

After the e-scooter has been folded successfully, use one hand or two to hold the folding-level to transit.



MAINTAIN ME

23

24

Daily Maintenance

Electric scooter cleaning and storage

If there is a mark on the body of your Reid eScooter, wipe it with a small amount of water with a soft cloth. If it is difficult to clean, you can use a toothbrush to brush it repeatedly then use a damp cloth to clean in. If the body has plastic scratches, you can use sandpaper or other abrasive materials for polishing.

Note

1. Do not use alcohol, gasoline, kerosene or other corrosive, volatile solvents to clean, otherwise it will seriously damage the body and internal structure. It is forbidden to use a pressure fun spray and flush. Make sure that the charging cable is unplugged and the rubber cap has been tightened when cleaning, otherwise it may cause an electric shock or accident due to water intake.
2. Store you Reid eScooter in a dry and cool room as much as possible to avoid accelerating of ageing. Failure to do so will reduce the usage life of the battery over time.
3. When the scooter is fully charged and not in use, it needs to be recharged every 3 months to avoid battery over-discharge protection.

Electric scooter battery maintenance

1. Do not use other brand of batteries, otherwise there may be security risks.
2. Do not touch the battery contacts and do not open the battery compartment. Any tampering of this may cause a short circuit, potentially damaging the battery and causing personal injury.
3. Only use the original charger for charging, otherwise it may cause damage or a fire.
4. Inappropriate disposal of used batteries may result in serious environmental pollution. Disposal of waste battery packs must be in accordance with local regulations.

5. Do not place the battery in a high temperature environment higher than 50 °C or lower than -20 °C (for example do not expose the eScooter or its battery pack to the car in summer) otherwise it may cause a malfunction, or even a risk of fire. The ideal temperature for maximum mileage and performance is between 20°C and 25°C and riding below 0°C will severely decrease battery life and performance. In some instance, at -20°C the mileage may be only half or less than at optimal temperature.

Note:

It is forbidden for non-professionals to remove the battery pack. Failure to do so may result in serious electrical faults or safety short-circuits.

Disc brakes debug

If you feel the brake is tight when you are riding, you can adjust the disc brake by loosening the screw on the Rotary knob, with a M5 hex wrench (as shown in the picture below). Turn the Rotary knob slightly to the right and tighten the screw with a M5 hex wrench. If you feel the brake is loose, you can turn the Rotary knob slightly to the left, after loosening the screw on the Rotary knob with a M5 hex wrench and then tighten the screw.

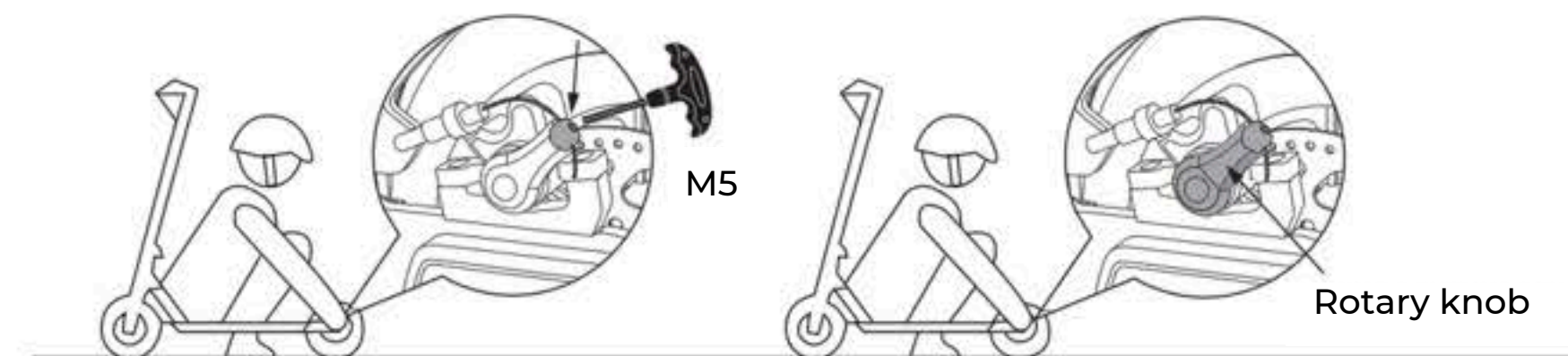

Alternatively, take your electric scooter to the nearest service centre for adjustment.

Parameter Table

Parameters	Description	Specifications
Product dimensions	LxWxH(MM)	1120*510*1210
	Folding Size LxWxH(MM)	1120*510*530
Weight	Total scooter (KG)	15
Ride limits	Rider weight maximum (KG)	100
	Rider weight minimum (KG)	30
	Rider age	12-50
Main parameter	Rider height (CM)	120-200
	Max speed (KM/H)	25
Charger	Max mileage (KM)	30-35
	Max slope	10-15%
	Road	Shall not exceed step above 1cm, and shall not exceed gap over 3cm
	Working temperature	-10-40°C
	Charging temperature	0-40°C
	Stock temperature	-20-45°C
	Waterproof level	IPX4

Parameters	Description	Specifications
Battery pack	Battery manufacturer	Guangxi Zhongke Puhui Energy Co., LTD
	Battery model name	PH36-7.8
	Rated voltage (VDC)	36
	Maximum charge voltage	42
	Rated capacity	7.8Ah
	Protection	Temperature, short circuit, undervoltage, overcurrent, overcharge, overdischarge
Motor	Rated Power [W]	290
	Max Power [W]	500
Charger	Charge manufacturer	Shenzhen Fuyuan Power Co., LTD
	Charge model name	FY0634201500
	Rated power [W]	63
	Rated voltage input (VAC)	100-240
	Rated voltage output (VDC)	42
	Rated current output (A)	1.5
	Charging time (H)	6-6.5

Height: The height of the body to the ground.

Endurance: Electric scooters are fully charged, load is 100kg, ambient temperature is 25°C without wind, maximum speed is 25kph. However, the actual cruising range varies with driving habit, roads, ambient temperature, wind speed and other factors.

Note: Data and parameters vary by mode. Subject to change without notice.

Warning

1. To reduce the risk of injury, user must read the instructions manual.
2. Prolonged exposure to UV rays, rain and the elements may damage the enclosed materials.
3. Store indoors when not in use.
4. Risk of fire, no user serviceable parts
5. Use only with specified charger in instructions

Error Code Chart

Boost Error Codes			
Code	Problem	How To Troubleshoot	Photo
01	Instrument/Control Communication Failure	Check if this joint is loose	1
02	Handlebar Failure	Check if this joint is loose or if the throttle is stuck	2
04	Battery Failure	Check if the battery can be charged	3
08	Motor Temperature Protection	Check if the motor is hot or if the motor temperature protection test line is loose	4
10	Controller Internal Fault or Phase Line Short Circuit	Check if the controlled is OK or if the three phase lines and short	5
20	Motor Hall Failure	Check if this joint is loose	6
40	Brake Failure	Check if this joint is loose	7



Warranty

Your eScooter has a 1-year warranty from the date of purchase.

If you're having an issue with your eScooter, we want to help resolve it. In the first instance, please contact the store where you purchased the product. If you experience any difficulty settling a warranty claim with your retailer, please contact us directly. Likewise, should anything feel loose or not right then please stop using your product immediately and get in contact with the retailer you purchased it from or us directly.

Register your eScooter with us via the QR code below so we can quickly and easily verify your purchase for your warranty. Should your eScooter ever be stolen, you can also get in touch with us to retrieve your serial number which is often wanted by the authorities.

Register Your eScooter here



Battery Care

- If you have an electric Reid product, here are some tips for looking after the battery to prolong the life of the unit and to ensure user safety:
- Never leave batteries charging in a building that is unattended or overnight when you are sleeping in the property.
- Unplug or disconnect from the battery once charging is complete. Do not allow the battery to overheat and ensure it is charged on a hard surface where heat can disperse.
- Regularly monitor and assess for damage to the battery and the charger, following the manufacturer's guidance for replacement or repairs.
- Ensure smoke alarms – preferably interlinked detectors around the property - are fitted where charging is taking place and, if possible, store and charge away from the main living area.
- If your eBike or eScooter is to be left unused for a prolonged period of time, ensure that you top up the battery charger at least every 3 months to prolong the life of the cells.
- Batteries should be stored between 5C and 30C to prolong the life of the battery cells and reduce degradation.

Charging Process

Step 1: Be sure to check your battery charge socket for moisture and debris before recharging.

TIP: If it is dirty please return your bike to your dealer so it can be cleaned without risk of short-circuiting the system.

Step 2: Ensure you connect your charger to the battery charge socket prior to turning on the charger at the wall socket.

TIP: Your battery can be charged while fitted to the bike.

Maintenance of your Battery:

"Fast chargers" with more amperage output are not available or recommended. Replacement chargers can be ordered from your Reid Dealer.

NOTE: If the battery does not fully charge within 8 hours, stop charging and consult with your Reid Dealer.

Charging Lights

Charger Indicator Light

LED Colour	Status
Green (without battery connected)	Charger OK (ready to charge)
Red (with battery connected)	Charging in progress
Green (with battery connected)	Charging complete
No light	Check mains power, charger may be fault

Battery Indicator Lights

Some batteries are fitted with an external charge state indicator which can help you visually determine the charge status of your battery by pressing the button located next to these lights.

Multiple LED type - the more LED lights illuminated the greater the charge level.
 Single LED type - Blue 70% to 100%, Green 30% to 70%, Reid 1% to 30%.

The battery can exist between the described state of charge, in which case the LED may flicker both relevant colours.

Maintaining Your Battery

Generally there are no user-serviceable features or functions of your battery. Only some batteries have user-serviceable fuses, please check with your Reid Dealer.

Lithium-ion batteries have exceptional abilities, but they are sensitive to heat and both their intended minimum and maximum voltages. Generally it is best to avoid allowing the internal cell temperature above 42 degrees celsius as this will cause damage to the chemistry of the batteries. Avoid charging when the battery is hot.

NOTE: The charging process will cause the battery to warm up and this is normal, while charging the battery should not exceed its safe operating temperatures.

Some Helpful Advice:

- Wait at least 30 minutes after riding before charging.
- Do not leave your battery in direct sunlight, small sheds or in your car.
- If you can feel the battery casing is warm, allow it sufficient time to cool down before recharging or using it.
- Do not leave your battery fully charged or fully flat for extended periods of time.
- If you do not ride regularly, ensure you charge your battery for at least 1 to 2 hours every 90 days, ideally maintaining charge status between 40% and 70% charged.
- Avoid charging your battery to 100% capacity after each ride.

Maintaining Your Battery

- Disconnect if charge is not completed after 8 hours
- Do not use outside & ensure charge socket on battery is totally dry before connecting.
- Ensure the charger is OFF prior to connecting to the battery.
- Do not charge in hot areas.
- Only charge on a hard surface away from flammable objects.
- Do not leave the charger and battery unattended while charging.

TIP: Only charging your battery to approximately 80% of its full charge can nearly double the useful lifespan of your battery!

How long does it take to charge the battery?

Total time will vary depending on the capacity of your battery and its current charge level. Generally you can expect a full charge of the battery (from 5% charge level) to occur between 4 and 8 hours after charging is commenced.



APP INTEGRATION

37

38

APP Download Guide:

The Reid eMobility app is available to download in the App Store and Google Play. You can also scan the QR code below to download and install the app.
Bluetooth password: 000000



Pairing Your eScooter

To pair your phone to your eScooter, please download the app and follow these instructions: Open the app, select the model of your scooter, create and account with us and then click the Bluetooth button in the top left hand corner of the main screen. Chose your device and enter the password: 000000, you are now connected.

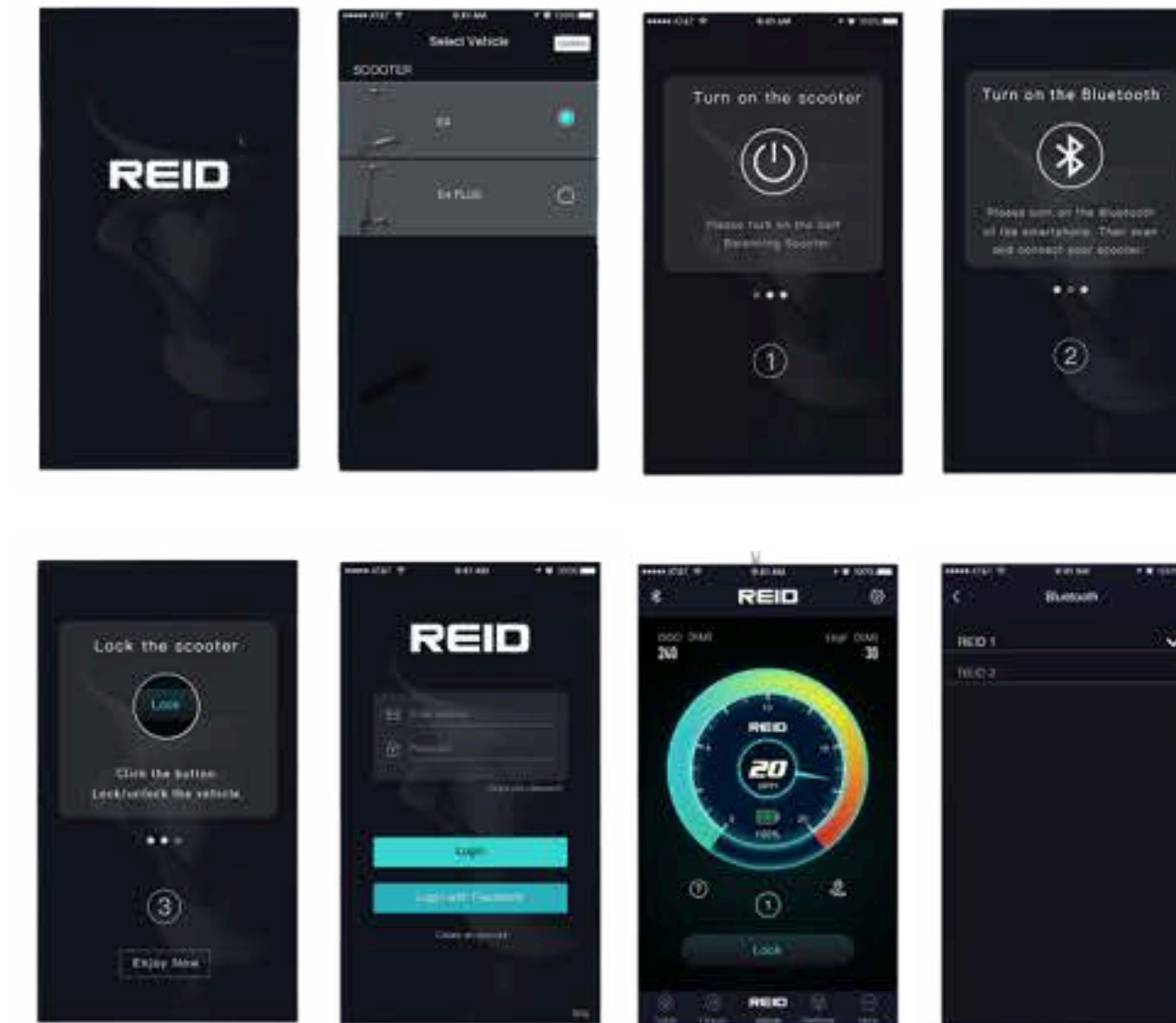



JOIN THE COMMUNITY

Instagram

Follow us on Instagram @reidbikes to experience the best of life on two wheels and more. We post everyday with new products, epic adventures and the latest eScooter news! We love sharing from our community of Reid Riders so use #reidbikes and #freedom for your chance to be featured.



FOLLOW US ON INSTAGRAM

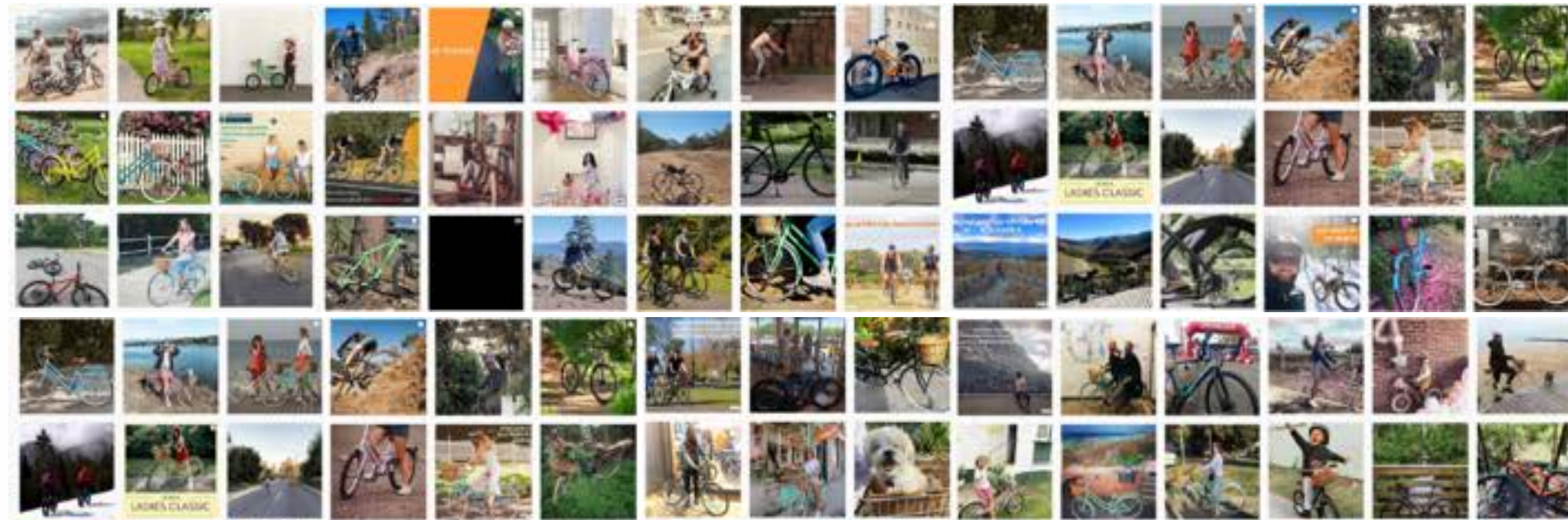

Facebook

We have dedicated Facebook pages for many of the countries we're found in. These pages will give you more Reid information specific to your country, so follow us to keep with the all the latest happenings.



FOLLOW US ON FACEBOOK

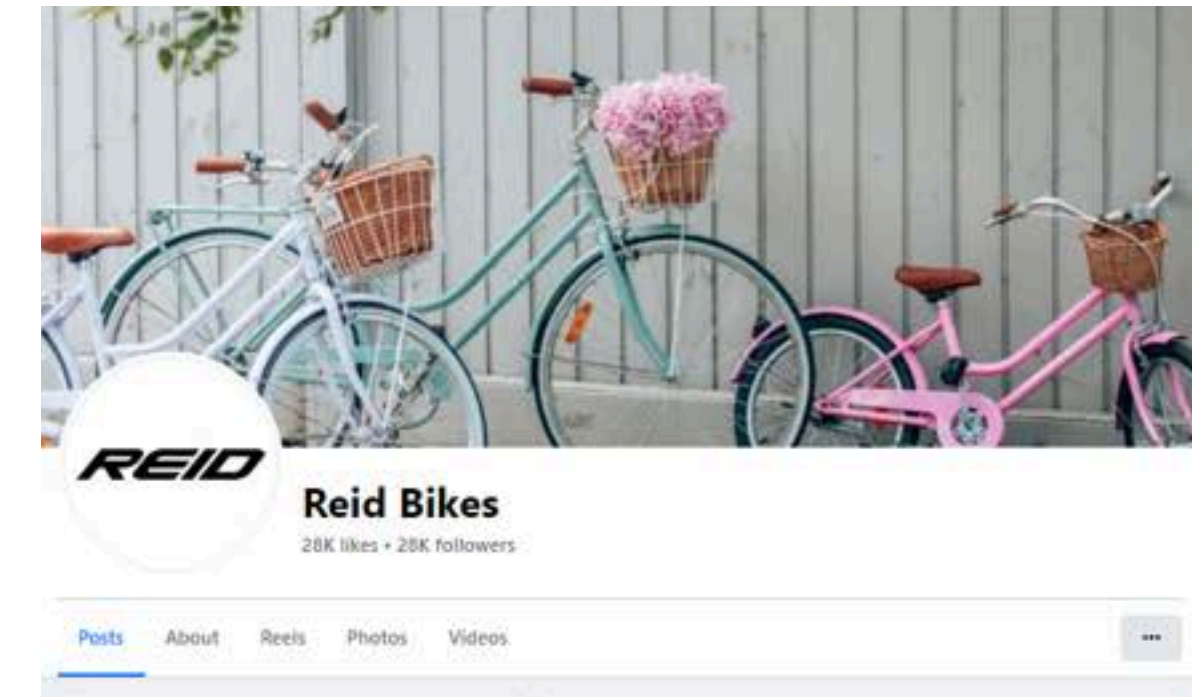

TikTok

Follow us on TikTok @reidbikes for awesome eScooter videos and more! We post regularly with new eScooter content, awesome adventure videos and the latest TikTok trends.

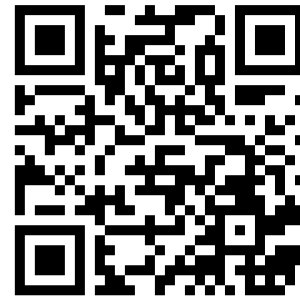

FOLLOW US ON TIKTOK



45



YouTube

Subscribe to our Youtube channel for in-depth maintenance and repair guides, as well as the most inspiring ride videos from around the world to help you plan your next adventure.

We have created a dedicated video series for our eScooters including everything you need to repair and maintain them. So should you need any help, then make sure to check them out and ask any questions further questions you may have as we monitor these and reply regularly.

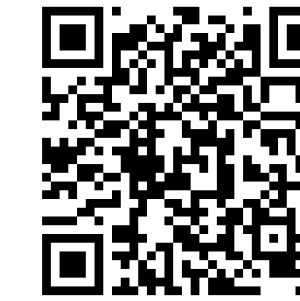

SUBSCRIBE TO OUR YOUTUBE CHANNEL



Reid E4 and E4 Plus Electric Scooter Showcase



Reid E4 Plus eScooter Video Series



Reid Race | E4 Plus eScooter vs Lamborghini vs Parkour...

46

Blog

From tips and tricks, advice on maintaining your eScooter and product guides to improve your experience, our blog is all you need to get the most from your Reid.

We regularly add new content so scan the QR code below to get started.

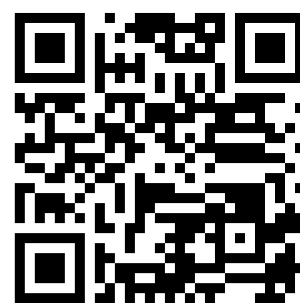

LEARN MORE ON OUR BLOG

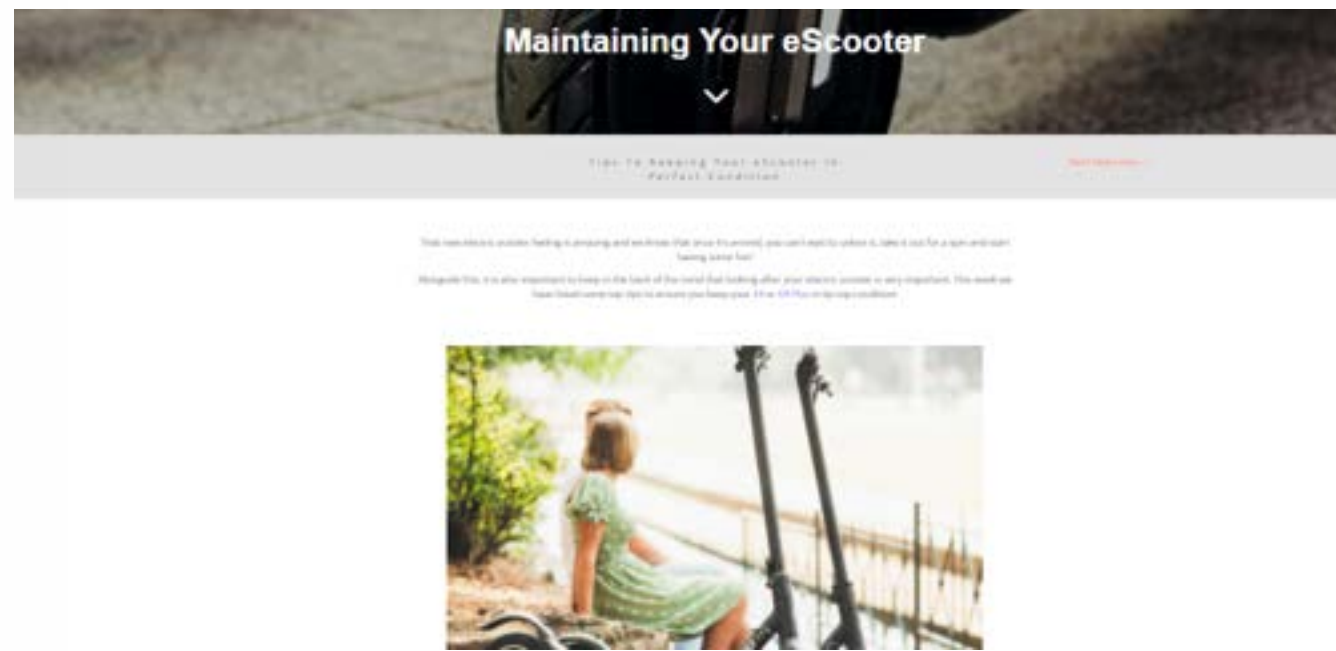

Reid Rider Of The Month

We love seeing our community enjoying their Reid's and exploring the world on their Reid! So much so, that we wanted to share these stories through a feature on our blog.

From city scootering to new adventures, these stories can teach and inspire you to make the most of your Reid.

If you would like to become our Reid Rider of the month, start sharing your Reid snaps on Instagram using #reidbikes and we might be in your DM's soon.





ENVIRONMENTAL PLEDGE

Recycle

Almost everything I'm packed in is recyclable, except a few plastic pieces needed to protect me on my journey to you. However none of this matters unless you take the necessary actions to recycle these, which helps to sustain the environments we love to ride in! Please recycle all you can from our carton.



Reuse

If you can't recycle then you can always reuse! 95% of the packaging we use is recyclable - but if you don't have recycling facilities near you, then you can always repurpose. Our bike carton makes a nice bed for a cat or spaceship for a child!



#BUYONEPLANTONE

We believe it is important to be constantly improving our sustainability practices so that the environments we love to ride in stay as healthy as possible.

Which is why we have decided to take an active role in tackling climate change, and have made a pledge to plant a tree for every Reid branded product we sell.

We believe that all businesses have a responsibility to offset the carbon they use. Even though our products already help people live a more eco-friendly lifestyle, we feel an obligation to do more and help make the world a greener place!



SCAN TO LEARN MORE

Eden Projects

Reid have partnered with the amazing Eden Reforestation Projects who plant a tree on our behalf for every Reid branded product we sell.

Eden Projects is a 501(c)(3) charitable organisation with the objective to plant 500 million trees each year by 2025.

Now widely recognised as one of the most effective reforestation projects on the planet, Eden also provides fair wage employment to impoverished people in developing countries.

This “employ to plant” methodology delivers multiplied socioeconomic and environmental benefits and we’re honoured to be a part of this powerful global initiative.



edenprojects.org
PLANT TREES | SAVE LIVES