

REID®

KD51C

Display Manual

Contents

Product Name and Model	1
Specifications	1
Appearance and Size	1
• Display appearance and size	1
• Remote appearance and size	1
Function summary and layout	2
• Function Summary	2
• Function Layout	3
General Operation	
• Switching the E-bike System On/Off	3
• Display Interface	4
• Switching Push-Assist Mode On/Off	4
• Switching the Lighting On/Off	5
• Assist Level Selection	5
• Battery Indicator	5
• Motor Power Indicator	6
• Error Code Indication	6
General Settings	7
• Trip Distance Clearance	7
• Backlight Contrast Settings	7
• Toggle the unit km/mile	8
General Parameter Settings	8
• Wheel Diameter Settings	8
• Speed limit Settings	8
Personalized Parameter Settings	9
• Battery Power Bar Settings	9
• Assist Level Settings (optional)	10
◦ Assist level mode options	10
◦ Assist level ratio Settings	10
• Controller Over-current Cut Settings (optional)	11
• Power Assistant Sensor Settings (optional)	11
◦ PAS Direction Settings	11
◦ PAS Sensitivity Settings	11
◦ PAS Magnet Quantity Settings	11
• Speed Sensor (optional)	12
• Throttle Settings (optional)	12
◦ Throttle Push-assistance Enable/Disable	12
◦ Throttle Level Enable/Disable	12
• System Settings (optional)	13
◦ Delay Time Settings of Battery Power	13
◦ Max Speed Limited	13
◦ Push-assistance button Enable/Disable	13
◦ Slow Start Up Settings	13

• Power-on Password Settings	14
• Power-on Password Enable/Disable	14
• Power-on Password Change	14
• Exit Settings	15
Recover Default Settings	15
Quality Assurance and Warranty Scope	15
I Warranty	15
II Others	15
Connection Layout	16
Warnings	16
Attached list 1: Error code definition	17
Attached list 2: Assist level ratio defaults	17

Product Name and Model

Intelligent Segment LCD display of E-bike Model:
KD51C.

Specifications

- Rated voltage: 24V/36V/48V
- Rated working current: 10mA
- Maximum working current: 30mA
- Off-state leakage current: <1uA
- Operating temperature: -20°C ~60°C
- Storage temperature: -30°C ~ 70°C

Appearance and Size

- Display appearance and dimensional drawing (unit: mm)

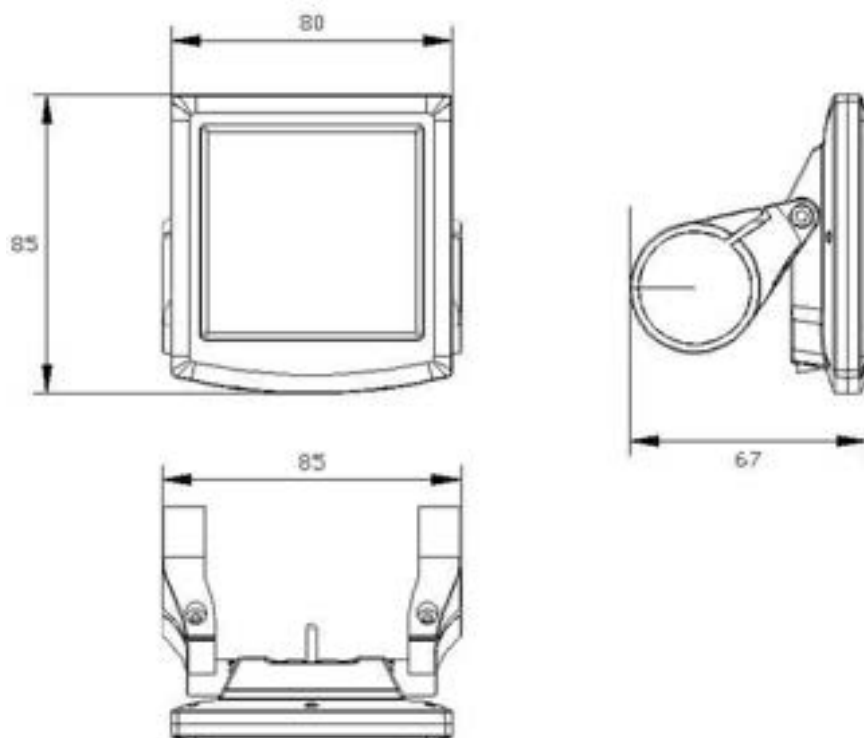

- **Remote appearance and dimensional drawing (unit: mm)**



Function summary and layout

- **Function summary**

KD51C has many functions to meet the riders' needs. The indicating elements are as follows:

- Smart battery indication
- Assist level
- Speed indication (incl. Current speed, max. speed and avg. speed)
- ODO and trip
- The push-assistance function
- Trip time
- The lighting On/Off
- Error code indication
- Motor power
- Range
- Various parameters settings (e.g., wheel size, speed-limited, battery level bar, Assist level, controller limited current, max speed, password enable, etc.)
- Recover default settings

- **Function Layout**

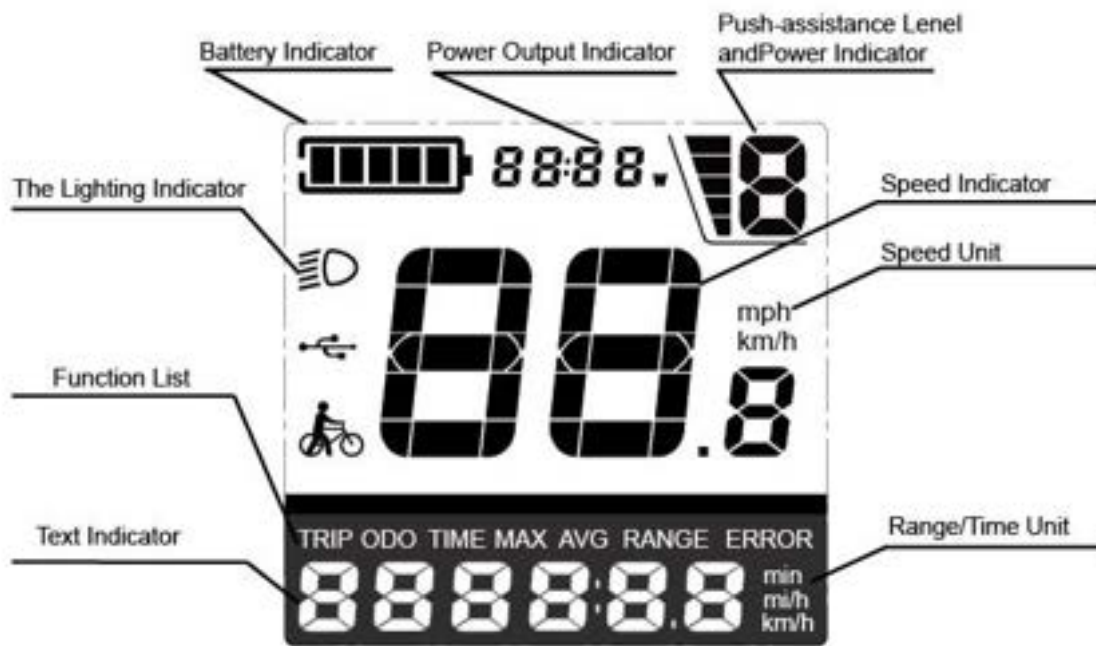

Functional Area Distribution

General Operation

- **Switching the E-bike System On/Off**

To switch on the E-bike system and provide the power supply to the controller, hold the On/Off button on the remote for 1 second.

To switch off the E-bike system, hold the On/Off button for 2s. The E-bike system no longer uses the battery power.

When E-bike system is switched off, the leakage current is less than 1 μ A.

■ **When the E-bike is parked for approx. 10 minutes, the E-bike system switches off automatically.**

- **Display Interface**

After switching on the E-bike system, the display will show Current Speed and TRIP by default. Press “i” button on the remote to switch between the indication functions below: Trip Distance (Km)→ODO (Km)→Trip Time (min)→Max. Speed (Km/h) → Avg. Speed (Km/h) → RANGE (Km)

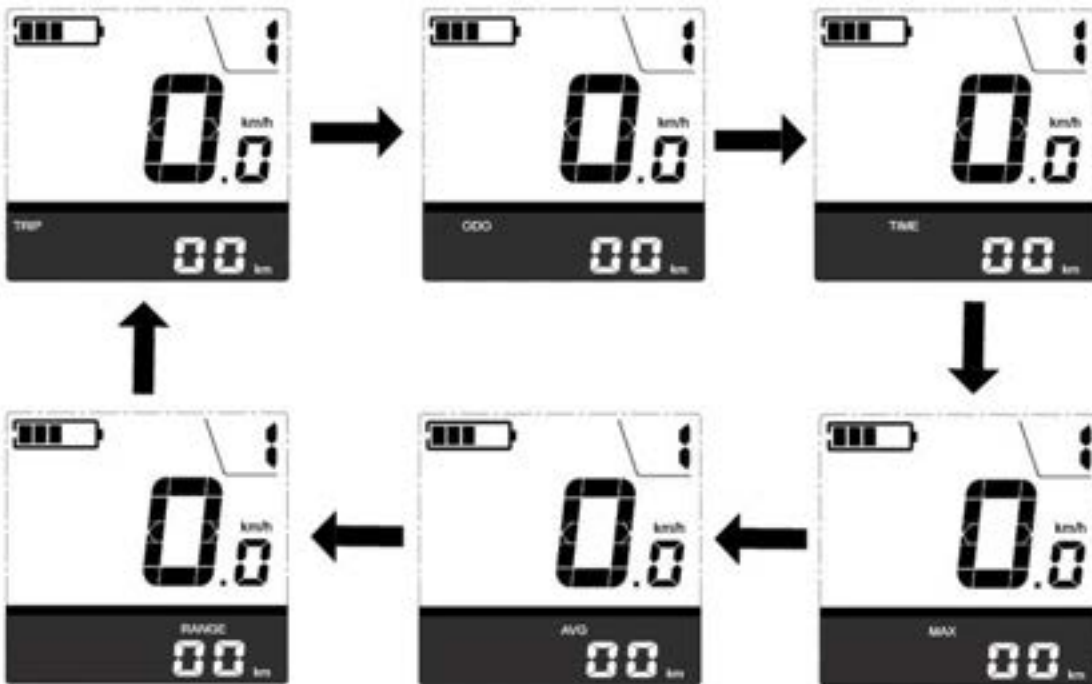

Display interface

- **Switching Push-assistance Mode On/Off**

To activate the push-assistance function, press and hold the “-” button on the remote.

After 2 seconds, the E-bike is activated to go at a uniform speed of 6 Km/h while the screen shows ‘’.



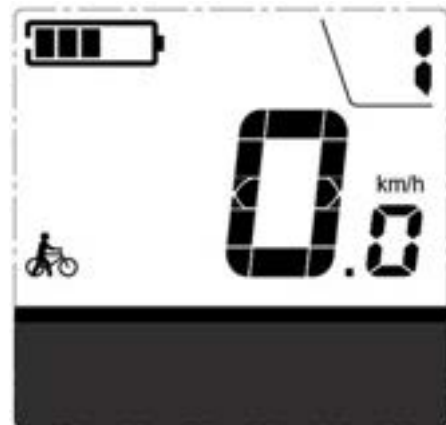

The push-assistance function is switched off as soon as you release the “-” button .



Push-assistance Mode

■ Push-assistance function may only be used when pushing the E-bike. Be aware of danger of injury when the wheels of the E-bike do not have ground contact while using the push-assistance function.

- **Switching the Lighting On/Off**

To switch on E-bike front light or rear light, briefly press the “” button on the remote. The display backlight brightness is automatically reduced while the screen displays “”. Likewise, briefly press the “” button again, the bike front light or rearlight can be switched off and display backlight recover its brightness. *If E-bike front light or rear light is independent of “” button, the “” button can only be used to switch on/off the display backlight.

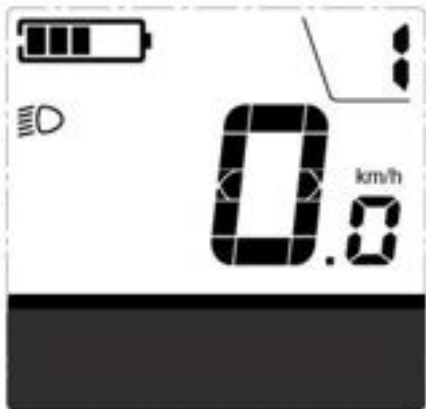

Switch the Lighting On/Off Interface

- **Assist Level Options**

The assist level of the E-bike drive can be changed anytime, even during riding. The assist level ranges from 0 to 5 (level 0 to level 5). The default assist level is “1” when the display is started. The output power is zero on Level “0”. Level “1” is the minimum output power. Level “5” is the maximum output power. Press +/- button on the remote to switch between the E-bike system assist levels and change the motor output power.

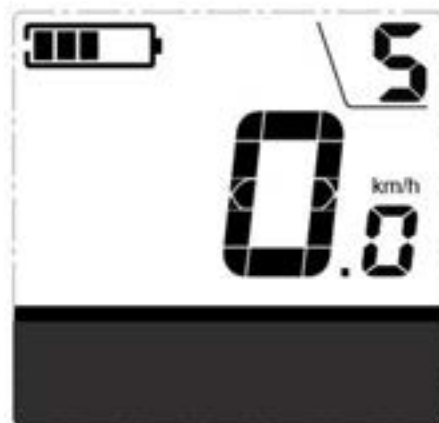

Assist Level “5”

- **Battery Indicator**

The five battery bars represent the capacity of the battery. Each bar is equivalent to a capacity of approx. 20%. The five battery bars are bright when the battery is in full voltage. When the battery is in low voltage, battery frame will flash to give a notice that the battery needs to be recharged immediately.

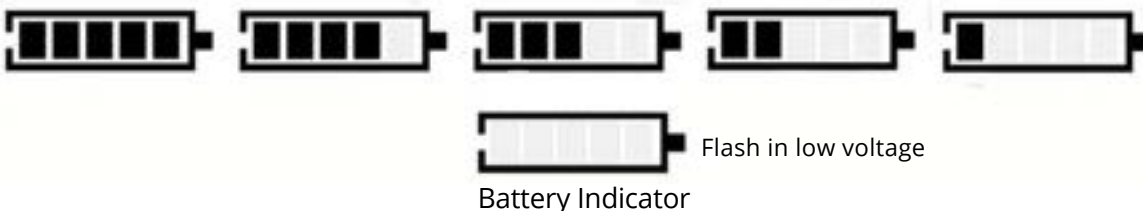

- **Motor Power Indicator**

The power of the motor can be read via below interface.

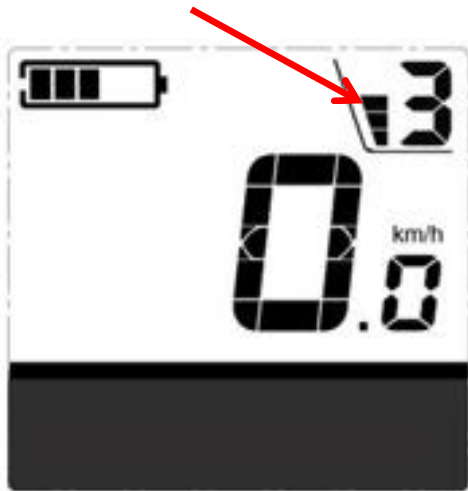

Motor Power Indication

- **Error Code Indication**

The components of the E-bike system are continuously and automatically monitored. When an error is detected, the respective error code is indicated in text indication area. Refer to the detail message of the error codes in Attached list 1.

■ **Have the display inspected and repaired when an error code appears. Or else, you will not be able to ride the bike normally. Please always refer to an authorized bicycle dealer.**



Error Code Indication

General Settings

To access General Settings menu, hold both the “+” button and the “-” button for 2s.

■ All the Settings are completed on a parked E-bike.

- **Trip Distance Clearance**

TC represents trip distance clearance setting. The default is N.

To clear trip distance, press the “+” button or the “-” button until the Y is displayed. To store a changed setting, press the “i” button and then access backlight settings

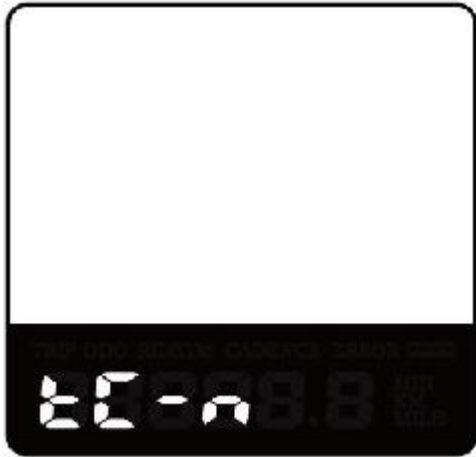

Trip Distance Clearance Settings Interface

- **Backlight Settings**

BL represents backlight settings. Level “1” is the low brightness, Level “2” is the medium brightness, and Level “3” is high brightness. The default level is “1”.

To modify the backlight brightness, press the “+” button or the “-” button to choose the desired setting item.

To store a changed setting, press the “i” button and then access the unit toggling settings.

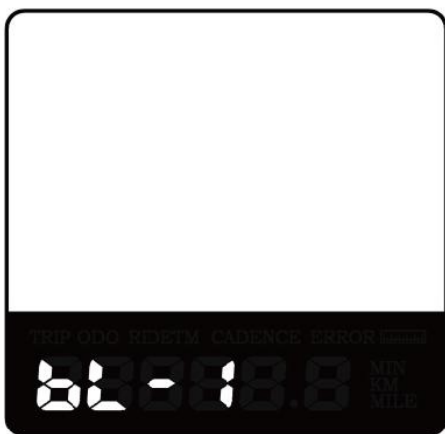

Backlight Brightness Settings Interface

- **Unit km/mi toggling**

U represents unit settings, “1” is mile and “2” is kilometer. The default value is “2”. To toggle unit, press the “+” button or the “-” button to choose the desired setting item, and then press the “i” button to confirm. To store a changed setting, press the “i” button and then access trip distance clearance settings again or hold the “i” button for 2s and exit General Settings.

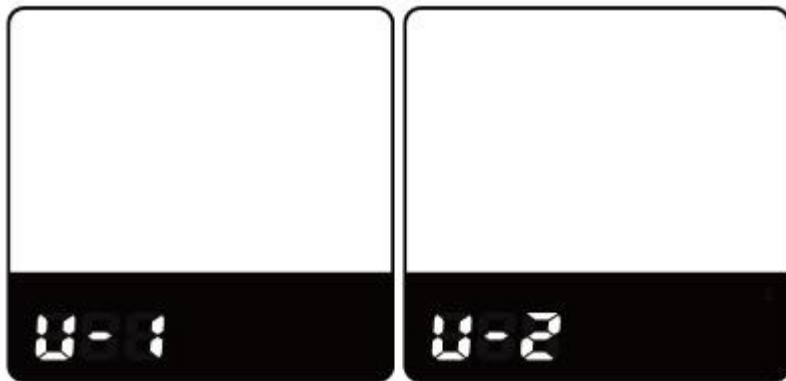

Mile and Kilometer toggling Settings Interface

General Parameter Settings

To access **General Parameter Settings** interface, hold both the “+” and the “-” button for 2s again (**General Parameter Settings**) and then hold both “-” button and remote “i” button for 2s again.

- **Wheel Diameter Settings**

LD represents wheel diameter settings. Optional values are 16, 18, 20, 22, 24, 26, 700C and 28. The default value is 700C.

To change basic settings, press the “+” or the “-” button to increase or decrease until the desired value is displayed.

To store a changed setting, press “i” button and then access the speed-limit settings interface.



Wheel Diameter Settings Interface

- **Speed-limit Settings**

LS represents the limited speed settings. When the current speed is faster than speed limit, the E-bike system will switch off automatically. Speed limit range is 12Km/h to 40Km/h. The default value is 25Km/h.

To change basic settings, press the “+” or the “-” button to increase or decrease until the desired value is displayed.

To store a changed setting and exit General Parameter Settings, hold the “i” button for 2s.



Speed Limit Settings Interface

Personalized Parameter Settings

Personalized Parameter Settings can meet a variety of individual requirements. Key-Disp displays work with different protocols, support the settings of different personalized items. There are 8 settings items:

Battery Power Bar Settings,

Assist Level Settings,

Controller Over-current Cut Settings,

Power Assist Sensor Settings,

Speed Sensor Settings,

Throttle Function Settings,

System Settings

Power-on Password Settings

To access **Personalized Parameter Settings** page, hold both the “+” and the “-” button for 2s (**General Settings page**) and hold both the “+” and the “-” button for 2s again.

To access the corresponding setting page, press the “+” or the “-” button until the desired item is displayed, and then press “i” button on remote to confirm.

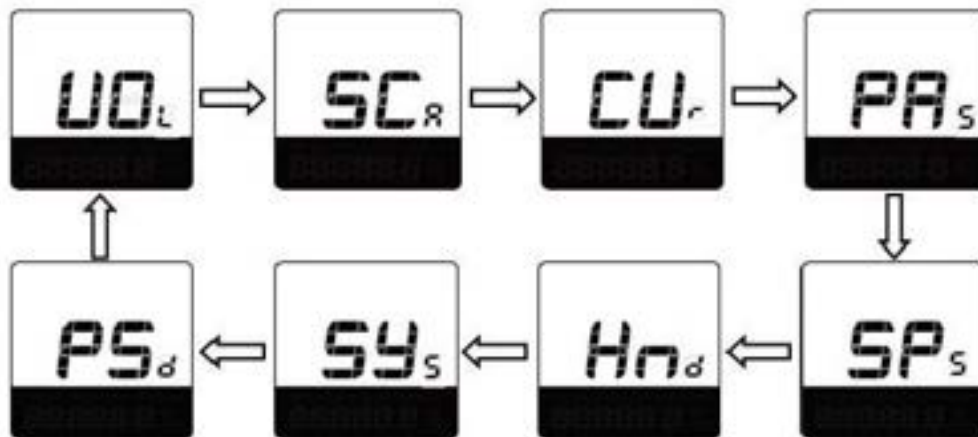

Setting Item Cycle Interface

- **Battery Power Bar Settings**

VOL represents voltage settings. Each bar represents a voltage value. 5 bars voltage values must be entered one by one. For example, VOL 1 is first bar voltage value. The default value is 31.5V. Press the “+” or the “-” button to increase or decrease the number.

To store a changed setting and access the second bar, press “i” button.

After 5 bars voltage values are entered completely, hold the “i” button for 2s to confirm and return to the previous menu.



Battery Power Bar Settings

- **Assist Level Settings (optional)**

'SCA' represents power assist level settings.

Assist level Mode Selection

In Assist level settings, there are 8 modes: 0-3, 1-3, 0-5, 1-5, 0-7, 1-7, 0-9, 1-9. The default mode is 0-5.

To change the mode of Assist level, press the "+" or the "-" button to choose the desired mode and press the "i" button for 2s to confirm and then access the assist level ratio settings automatically.



Assist Level Mode Settings Interface

Assist Level Ratio Settings

The speed of each level can be adjusted to meet different riders' needs by setting the ratios

For example, the default ratio is 50% for level "1"; the ratio range is "45-55 percent" for level "1".

To change the ratio of a certain assist level, press the "+" button or "-" button to choose the desired value, and press the "i" button to confirm and then move to the next level ratio settings.

After ratios of all levels are set, hold the "i" button for 2s to confirm and then return to previous menu. For ratio default values, please refer to Attached list 2.



Assist Level Ratio Settings

Controller Over-current Cut Settings (optional)

CUR represents controller over-current cut settings. CUR value can be changed from 7.0A to 25.0A. The default value is 15A.

To change basic settings, press the "+" or the "-" button to increase or decrease the value of the current.

To store a changed setting, hold the "i" button for 2s and return to previous menu.



Current Settings Interface

Power Assist Sensor Settings (optional)

PAS represents power assist sensor settings.

The PAS Direction Settings

“run-F” means forward direction, while “run-b” means back direction. The default value is “run-F”.

To change the direction of power assist sensor, press the “+” or the “-” button to select Forb.

To store a changed setting, press “i” button and then access PAS sensitivity settings.



PAS direction setting interface

The PAS Sensitivity Settings

SCN represents the sensitivity of PAS settings. The sensitivity value is “2” to “9”. “2” is the strongest, “9” is the weakest. The default value is “2”.

To change the sensitivity of PAS, press “+” or “-” button to choose sensitivity value.

To store a changed setting, press the “i” button and then access magnet quantity settings mode.



PAS Sensitivity Settings

Magnet Quantity Settings

n represents the numbers of magnets on PAS disk. The default number is 6.

To change the number of magnets on PAS disk, press “+” or “-” button to choose the desired quantity.

To store a changed setting, hold the “i” button for 2s and then return to previous menu.



PAS Magnet Setting

Speed Sensor (optional)

SPS represents speed sensor settings. The default value is 1
To change speed sensor settings, press the “+” or the “-” button to select the quantity of magnet head (the range is from 1 to 15).
To store a changed setting, hold the “i” button and then return to previous menu.



Speed Sensor Setting

Throttle Settings (optional)

Throttle Push-Assistance Enable/Disable

HL represents throttle push-assistance function settings. HL-N represents throttle push- assistance function is disabled. HL-y represents throttle push-assistance function is enabled.
The default value is N.

To enable throttle push-assistance function, select Y and hold i button for 2s to confirm and return to previous menu.

To disable throttle push-assistance function, select N and access Throttle Level Enable/Disable Setting below.



Throttle Push-assistance Enable/Disable Interface

Throttle Level Enable/Disable

HF-y means throttle speed is limited by current assist level while HF-n means throttle speed is not limited by current assist level.
The default value is n.

If you choose y, the maximum speed can only be the highest speed powered by current assist level when you twist the throttle.
If you choose n, the maximum speed is not limited by current assist level and you can override whatever level you are in and reach rated maximum speed when you twist the throttle.
Press +/- to set Y or N and press “i” button to confirm and return to throttle push assistance enable/disable setting interface or hold down the ‘i’ button for 2s to return to previous menu interface.

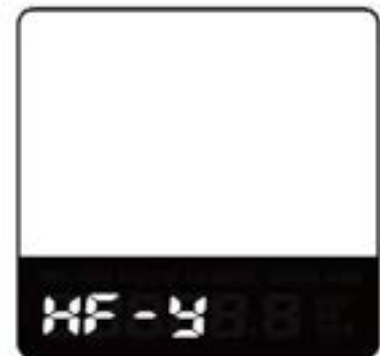

Throttle Level Enable/Disable Setting

System Settings (optional)

Delay Time Settings for Battery Power

dLy represents battery power delay time settings. The default value is 3s.

To change delay time settings, press the “+” or the “-” button to select delay time 3s, 6s, 12s. To store a changed setting, press the “i” button and then access the max speed limited.



Interface of Battery Power
Delay Time Setting

Max. Speed Limit

LS represents max. speed limit settings. The default value is 40Km/h.

To change Max speed limit setting, press the “+” or the “-” button to set the max speed from 25Km/h to 40 Km/h.

To store a changed setting, press the “i” button and then access push-assistance button enable/disable settings.

■ **The maximum speed upper limit is set by display manufacturer.**



Interface of Max Speed
Limit

Push-assistance Button Enable/Disable

PUS represents push-assistance button settings. Y represents push-assistance button is enabled, N represents push-assistance button is disabled. The default value is Y.

To change push-assistance button settings, press the “+” or the “-” button to choose Y or N. To store a changed setting, press the “i” button to confirm and access Slow Start Up settings.



Push-assistance button
Enable/Disable Settings

Slow Start up Settings

SSP represents slowly start up. The range is “1-4”, “4” is the slowest. The default value is “1”. To change slowly start up settings, press the “+” or the “-” button to select the desired value.

To store a changed setting, press the “i” button and return to Delay time settings for battery power or hold the “i” button for 2s to return to previous menu.



Slow start up settings interface

Power-on Password Settings

PSd represents power-on password settings. Power-on password is a 4-digit code. The default password is “1212”. Press i button to enter the interface where “P2, 0000” is shown on the screen. Please input the current password or default password’1212’.

Press i button to increase or decrease the number and press i button to confirm digits one by one until the correct 4-digit password is completed. Press i button to access power-on password Enable/Disable Settings.

Otherwise stay in password input state.



Power-on Password Input Interface

Power-on Password Enable/Disable

To change power-on password enable/disable settings, press “+” or “-” button to choose

Y or N. Y means power-on password is enabled. N means power-on password disabled. The default value is N.

If you choose Y, press the “i” button and then access power-on password change interface.

If you choose N, you will exit the power-on password settings interface and return to previous menu.



Power-on Password Enable/Disable Interface

Power-on Password Change

When the display shows P3, 0000, you can set a new power-on password. Press the “+”

or the “-” button to change the number and press the “i” button to confirm digits one by one until a new 4-digit password is completed.

To store the new power-on password, hold the “i” button for 2s and then exit settings.

When switching on the E-bike system next time, the display will show P1,0000, please input the new password to power on.



Power-on Password Change Interface

• Exit Settings

In the settings interfaces,

Press the “i” button is to confirm the input.

Hold down the “i” button is to store the settings, and exit the current settings.

Hold down the “-” button is to cancel the operations but not to store setting data, and return to previous menu.

■ **If there is no operations in one minute, the display will exit the settings state automatically.**

Recover Default Settings

DEF represents recover default settings. The default value is N.

To access recover default settings, hold both the “-” and the “i” button for 2s.

Press “+” or “-” button to choose Y or N again. N means not recovering default settings.

Y means recovering default settings.

When it is Y, hold the “i” button for 2s to recover default settings; the display shows

DEF-00 at the same time, and then return to general display state.

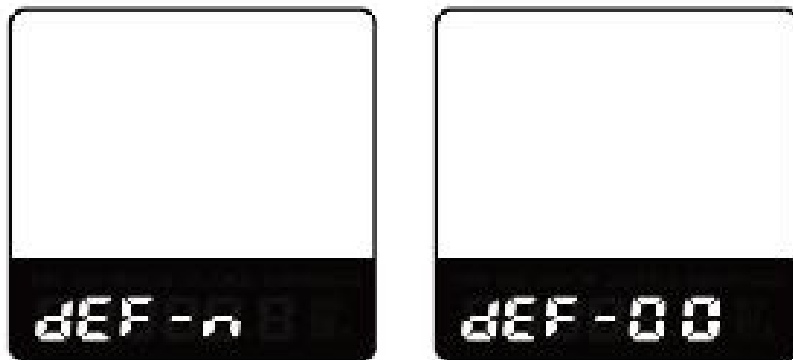

Recover Default Settings Interface

Quality assurance and warranty scope:

I. Warranty:

- 1) The warranty will be valid only for products used in normal usage and conditions.
- 2) The warranty is valid for 24 months after the shipment or delivery to the customer.

II. Others

The following cases do not belong to warranty scope:

- 1) The display is demolished.
- 2) The damage of the display is caused by wrong installation or operation.
- 3) The shell of the display is broken after the display is out of the factory.
- 4) The cable of the display is broken.
- 5) Beyond warranty period.
- 6) The fault or damage of the display is caused by the force majeure (e.g., fire earthquake, etc.).

Wire connection layout

Connector wire sequence

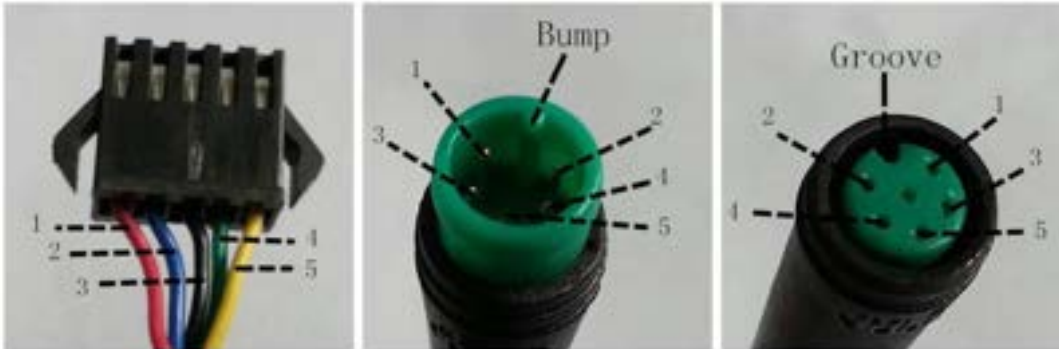

Connector to controller

Display connector

Mating connector to display

Wire sequence table

Wire sequence	Color	Function
1	Red (VCC)	+
2	Blue (K)	Lock
3	Black (GND)	-
4	Green (RX)	RX
5	Yellow (TX)	TX

■Some displays have wire connection with water-proof connectors, users can not see the color of lead wires in the harness.

Warnings:

1. Use the display with caution. Don't attempt to disconnect or link the connector when battery is power on.
2. Try to avoid hitting the display.
3. Don't modify system parameters to avoid parameter disorder.
4. Make the display repaired when an error code appears.

■***This manual instruction is a universal version for DISPLAY KD51C. Some versions of this display may be different from specification to specification as to the software. Please always refer to an actual version.***

Attached list 1: Error Code Definition

Error Code	Definition
21	Current Abnormality
22	Throttle Abnormality
23	Motor Phase Abnormality
24	Motor Hall Signal Abnormality
25	Brake Abnormality
30	Communication Abnormality

Attached list 2: Assist level ratio defaults

Level PAS level mode	1	2	3	4	5	6	7	8	9
0-3 /1-3	50 %	74 %	92 %	—	—	—	—	—	—
0-5/ 1-5	50 %	61 %	73 %	85 %	96 %	—	—	—	—
0-7/ 1-7	40 %	50 %	60 %	70 %	80 %	90 %	96 %	—	—
0-9/ 1-9	25 %	34 %	43 %	52 %	61 %	70 %	79 %	88 %	96 %

REID®

KD51C

Display Manual